



U190P Floor Sweeper Instruction Manual



We explore safer, higher-end and more user-friendly cleaning equipment through technical advantage and idea innovation.



Preface

This instruction manual contains all the information that you need to use and maintain the machine. Please read it carefully before getting started. Only with correct operation and regular maintenance can the machine be kept in its best working condition.

This instruction manual is an important part of the product and should be kept together with the machine.

If this manual is lost, please contact us immediately and we will be glad to provide you with a new one. All technical details included in this manual are property of Anhui Chancee Technology Co., Ltd and are protected by law.

In this manual we use illustrations to show the components and functions of the machine. It is possible that some of them contain details that are slightly different from those of yours. However, all the instructions presented here still apply to your product and should be followed strictly during the operation.

Some components of the product may be harmful or dangerous and we have tried our best to include them in this manual. **It is the user's obligation to pay special attention to them during the work.** However, since it is impossible for us to point out all potential dangers, we expect you to be extremely cautious during the work so as to protect the machine, yourself and other people in the working area.

Only accessories from the original manufacturer can be used on the machine. Using accessories from other sources may lead to low working efficiency or even accidents in extreme cases.

We usually modify or improve our products to meet the latest market demand. However, this is **NOT** suitable for machines that have been sold. We will **NOT** be responsible for any injury or loss caused due to the user's improper operation either.

If you have any question, complaint or suggestion, please feel free to contact us and we will be at your service with all our knowledge and enthusiasm.

We wish you a pleasant experience with our product!

Contents

Components and technical parameters

Chapter 1 General description 1/2

- 1.1 Contents and purposes
- 1.2 General instructions
- 1.3 Safety requirements for the batteries
- 1.4 General safety requirements

Chapter 2 Operating the machine 3/5

- 2.1 Buttons and pedals of the machine
- 2.2 Operation process of the machine
- 2.3 Cautions during the operation

Chapter 3 Regular inspection and replacement of damaged parts 6/10

- 3.1 Regular inspection
- 3.2 Adjustment of the main groom
- 3.3 Replacement of the main groom
- 3.4 Adjustment and replacement of the side grooms
- 3.5 Replacement of the filter element
- 3.6 Adjustment of the height of the baffles
- 3.7 Replacement of the fuses
- 3.8 Removal and installation of the garbage can
- 3.9 Maintenance of the batteries
- 3.10 Cleaning of the filter screen
- 3.11 Cleaning of the filter element of the vibrator

Chapter 4 Common problems and solutions 11

Chapter 5 Maintenance 12

- 5.1 Operating conditions
- 5.2 Maintenance timetable

Chapter 6 After-sale services 13

Warranty card

Components



- | | | |
|------------------------|----------------------|-------------------|
| ① Steering wheel | ⑥ Alerting light | ⑪ Inspection port |
| ② Baffle lifting pedal | ⑦ Water tank | ⑫ Ceiling |
| ③ Headlight | ⑧ Anti-slippery tire | ⑬ Supporting rod |
| ④ Side groom | ⑨ Groom cover | ⑭ Taillight |
| ⑤ Leather Seat | ⑩ Controlling panel | ⑮ Debris hopper |

Technical parameters

Category	Parameter	Category	Parameter
Cleaning width (mm)	1,900	Suction motor (W)	216
Water tank capacity (L)	50 * 2	Driving motor (W)	1,200
Charging time (h)	6	Vibrator motor (W)	60
Working time (h)	4	Walking speed (km/h)	0-10
Battery capacity (V/Ah)	48/100	Grade ability (%)	15
Rolling brush motor (W)	1,000	Total weight (kg)	650
Side brush motor (W)	90 * 4	Product size (mm)	2,000*1,900*2,000

Chapter 1 General description

1.1 Contents and purposes

- Potential risks concerning the use of the machine are listed in the following sections. Since most accidents take place when safety rules are ignored, it is necessary that you read them carefully and take precautions before getting started. The best guarantee against any accident is a careful and cautious user, which might be better than other precautions available. When using the machine, pay special attention to the people in the working area, especially children.

1.2 General instructions

- Before any maintenance and repair, turn off the power and remove the key from the general switch.
- The machine can only be operated by qualified personnel. Children and disabled people are strictly forbidden to use it.
- Keep the battery away from sparks, flames and smoke.
- Do **NOT** use the machine in places with dangerous, flammable or explosive gases, liquids or water vapor.
- The machine can be used to clean regular garbage. It must **NOT** be used to clean silk ropes, belts, high-temperature sundries, accumulated water, or flammable, toxic and harmful materials, so as to avoid entanglement and burning of the brushes.
- Keep loose clothing, hair, fingers and other parts of your body away from the air vent and any moving part of the machine.
- Turn off the power if you do not use the machine.
- Do NOT use the machine in slopes with an inclination larger than the fixed value.
- Do **NOT** smoke when charging the battery.
- Do **NOT** use the machine in very dirty places. Repeat the sweeping if there is too much garbage.
- The machine should be stored at a temperature between -10 °C and 40 °C.
- The temperature of the working area should be between -10 °C and 40 °C, and the humidity should be between 30% and 95%.
- Do **NOT** use the machine as a means of transportation.
- When the machine is not moving, stop the brushes to avoid damage to the ground.
- In the event of a fire, use a **POWDER** extinguisher rather than water.
- When a failure is produced, make sure that it is **NOT** due to the lack of regular maintenance.

- If some spare parts need to be replaced, you can purchase them from the original manufacturer or an authorized distributor.
- To make sure that the machine is in the proper operating and safety condition, the user or service center must abide by what is stated in Chapter III and Chapter V.
- Attention must be paid even when the machine is about to be dismantled and scrapped. Since some harmful substances (such as batteries, waste oil, etc.) have met the required standards, they should be sent to a specific center for treatment.

1.3 Safety requirements for batteries

- The battery must **NOT** be in a low voltage state; charge the battery **as soon as possible** when the voltage is below **42 V**;
- To avoid electric leakage, keep the battery dry and clean;
- Do **NOT** put metallic objects (such as tools) on the battery to prevent it from being short-circuited and burned;
- The charging room should be well ventilated;
- When the key switch is in the position “ON”, do **NOT** install or remove the battery;
- Before installing or removing the battery, disconnect first the negative wire (-) and then the positive wire (+). When rewiring, pay special attention to the polarity of the battery, as wrong connection would probably damage electrical components;
- Avoid direct contact between the positive and the negative electrodes, because it would cause a large current short circuit, high heat or even a fire.

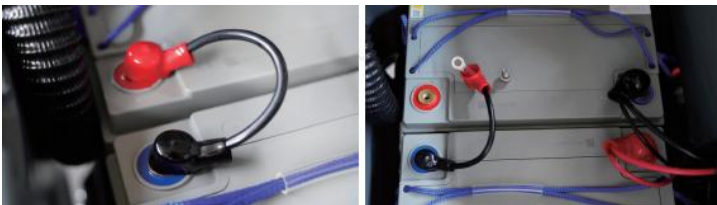

1.4 General safety requirements

- In addition to what is mentioned in this manual, the general safety requirements must also be observed. Even if you have used a similar product before, we recommend that you read this manual carefully so that you can save much time as well as take precautions to protect the machine and yourself. It is vital that you become familiar with all the accessories and components before turning on the machine. Read our instructions carefully so that you will not be confused when you get started.

Chapter 2 Operating the machine

2.1 Buttons and pedals of the machine

2.1.1 Key controlling buttons of the machine

- ① Loudspeaker button
- ② Sprinkler button
- ③ Headlight button
- ④ Main light button
- ⑤ Forward/backward button
- ⑥ Sweeping button
- ⑦ Power display
- ⑧ General switch

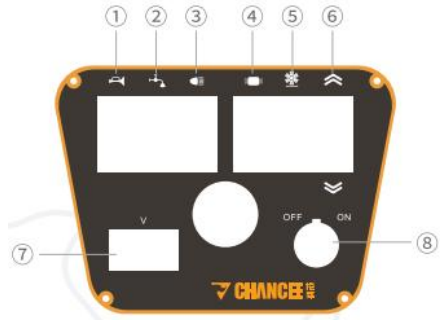

Attention:

1. The sweeping button has three gears:

The front gear: the main groom, the side grooms and the suction motor are started; the main groom and the side grooms are lowered and the machine is ready for work.

The middle gear: the main groom, the side grooms and the suction motor are stopped; the main groom and the side grooms do not rise, and the operator can adjust the height of the brushes.

The restart gear: the main groom and the side grooms rise.

Sprinkler valve: before turning on the sprinkler button, make sure that the sprinkler valve is open; when the sprinkler button is turned off, close the valve to prevent splashes.

- ① Accelerating pedal
- ② Brake pedal
- ③ Front baffle lifting pedal (step on this pedal when you need to remove large garbage)



2.1.2 Charging the batteries

- A socket with a minimum diameter of 6 mm is required.
- If you need to stop charging the batteries, disconnect directly.

2.1.3 Adding water to the water tank

- Before using the machine, add clean water to the clean water tank. Pay attention to the water quality so that the waterway will not be blocked.

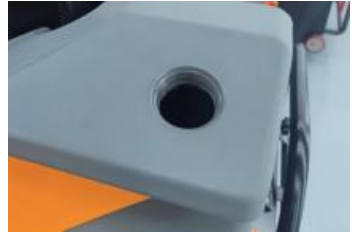

2.2 Operating the machine

2.2.1 Before the operation

- Before getting started, make sure that no doors or covers are open and the garbage can is correctly closed. If the machine does not work after transportation, check every part first.

2.2.2 Power display

- Insert the start key in the steering wheel console and turn the start switch clockwise to the "ON" position. The current voltage of the battery will be displayed in three seconds. If the voltage is lower than 42 V, charge the battery first.

2.2.3 Starting the machine

- Be seated on the driver's seat.
- Step on the brake pedal and turn the start key to the "ON" position.
- Move the machine to the work area using the steering wheel and the forward/backward button.
- The moving speed can be adjusted from 0 to the maximum value by pressing the accelerator pedal.
- Press the sweeping button to start work, and use the steering wheel, accelerator pedal and forward/backward button to move the machine.
- The garbage can must be closed during the sweeping work.
- The sweeper applies automatic and one-button operation. When the sweeping button is turned on, all motors (including the main groom motor, side brush motor, and ventilator motor) will automatically start, and the main groom and side grooms will automatically descend.

2.2.4 Stopping the machine

- Release the accelerator pedal to stop the machine.
- Press the stop button and all sweeping functions are stopped, and the main groom and side grooms are raised.
- Turn the start switch to the "OFF" position.

2.3 Cautions

2.3.1 General instructions

- When the brushes are rolling, do **NOT** leave the machine in the same place for a long time, because this would leave unnecessary marks on the ground.
- If you need to remove large light garbage, you can lift the front baffle so that the garbage can be recycled into the garbage can. Note that when the front baffle is lifted, the suction efficiency of the machine will be reduced.
- In order for the machine to achieve its best cleaning effects, the filter screen should be vibrated regularly: stop the machine, press the dust-vibrator button to start the dust-vibrator motor and keep it operating for one minute.
- During the work, the filter screen should be vibrated every 30 minute on average (depending on the working area)
- The machine cannot collect garbage when the filter screen is blocked or the garbage can is filled. Do **NOT** use the machine on the damp ground to prevent the filter screen from being damaged.
- The garbage can must be discharged every time when the work is finished.

2.3.2 Discharging the garbage can

- Release the pedal to stop the machine.
- Open the buckle of the garbage can.
- Pull the garbage can downward, drag it out and take out the garbage.
- Put the garbage can back in the machine and fasten the buckle.

2.3.3 Push/drag of the machine

- Push/drag the machine when it is turned off or when there is a fault.
- Make sure that the speed is not greater than 5km/h.
- Press the button to the forward gear when moving the machine forward, and to the backward gear when moving it backward.

2.3.4 Storage of the machine

- If the machine is not about to be used within 30 days, please disconnect the battery and store it in a clean and dry place.

Chapter 3 Regular inspection and replacement of damaged parts

3.1 Regular inspection

Regular inspection items		Time interval (h)				
		4	50	100	200	500
1	Battery power					
2	Carbon brushes of the motors					
3	Is the main groom entangled?					
4	Are there particles and/or crystals in the water tank?					
5	Buttons on the control panel and electronic components					
6	Are the brushes worn?					
7	Is the filter blocked?					
8	Does the sprinkler joint leak?					

3.2 Adjustment of the main groom

The main brush is capable of sending garbage to the garbage can through its own rotation.

- Any adjustment must be realized on the flat ground.
- Make sure that the main brush is stopped and the machine is powered-off.
- Check the width of the contact surface with the ground. The appropriate width range is 2-4 cm.
- If the width of the contact surface is not within this range, adjust the position of the main brush.

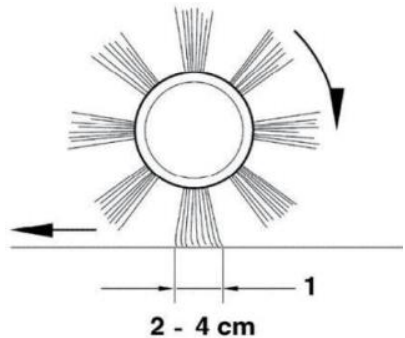

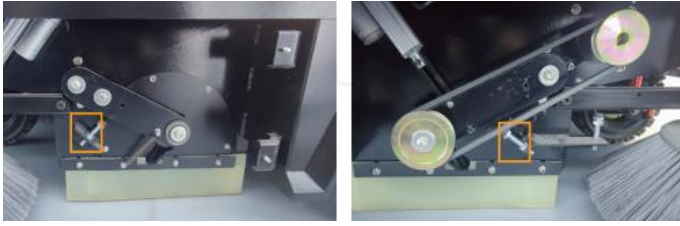

3.3 Replacement of the main groom

- Before replacing the main brush, place the machine on the flat ground and make sure that it is powered-off.
- Open the right board of the machine, use an open-end wrench to remove the rocker arm of the main brush, the sealing plate and the fixing nuts of the baffle bracket.
- Take out the old brush and replace it with a new one (first install the sealing plate nuts, then the baffle bracket nuts and finally the rocker arm nuts).
- Turn on the sweeping button and check whether the main brush works normally; if not, use the rocker arm to adjust it.

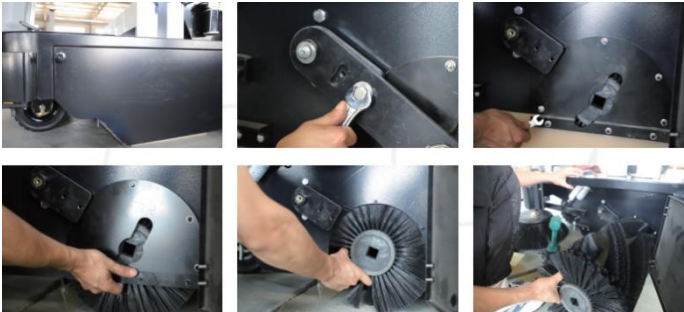

3.4 Adjustment and replacement of the side grooms

The side brushes can sweep out garbage in dead corners so that the cleaning efficiency of the machine can be boosted.

3.4.1 Adjustment of the side brushes

Use the adjusting nuts on both sides to adjust the position of the side brushes.



3.4.2 Replacement of the side brushes

- Step 1: loosen the Allen screws of the side brushes;
- Step 2: remove the screws shown in the picture and take out the old brush(es); Install the new brush(es) in the reverse direction.

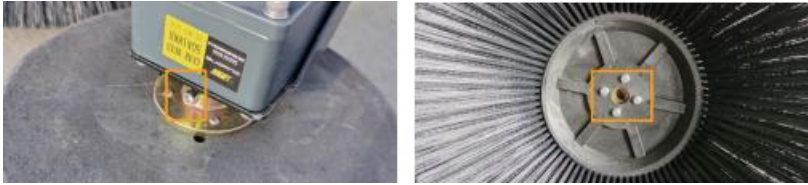

Note: use gloves to protect your hands from being hurt.

3.5 Replacement of the filter element

The filter is used to remove dust and small particles. When dust and high-density garbage such as leaves cannot be cleaned, the filter element needs to be replaced.

- Remove the nuts on the panel of the dust-vibrator motor and pull out the filter element.
- Remove the screws inside the filter element and replace the filter element.
- Apply lubricating oil to the seal of the new filter element.
- Install the filter element in the reverse order.

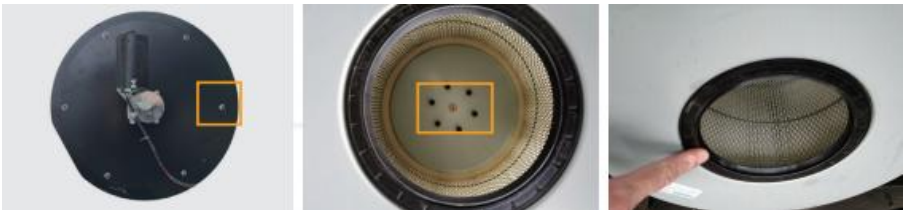

3.6 Adjustment of the height of the baffles

The main function of the baffles is to concentrate the suction force of the sweeper. If the side and the rear baffles are off the ground, garbage may be missed during the cleaning.

- Take out the garbage can.
- Check if the baffles are complete. When the gap is larger than 20mm or the crack is larger than 10 mm, replace the corresponding baffle.
- Check whether the height of the baffles are between 0~3 mm. If it is not within this range, adjust the height of the corresponding baffle.

3.7 Replacement of the fuses

- When an electrical unit is overloaded or the current is too large, the corresponding fuse is blown automatically to protect the unit and the machine.

3.8 Removal and installation of the garbage can

- Make sure that the machine is powered-off.
- Open the buckle of the garbage can, pull the garbage can downward, drag it out and take out the garbage.
- Align the mouth of the empty garbage can with the sweeper, and slowly push it forward.
- Fasten the buckle.



3.9 Maintenance of the batteries

The sweeper is powered by four batteries of 12 V and the total system voltage is 48 V. The instructions below should be followed when maintaining the batteries.

- During the work, the battery voltage will gradually decrease; when the last bar of the voltmeter is flashing, please charge the batteries immediately.
- Before maintaining the batteries, please wear gloves to avoid contact with acid substances.
- Check regularly whether the battery cables are worn or loose, and replace them when necessary.
- The ends of the batteries should be kept clean, and there should be no dust on the battery surfaces, or the batteries may be burnt.

Alerts

- In order for the batteries to have a long service life, charge them immediately after using the machine; deep discharge is strictly prohibited, as it would reduce the capacity of the batteries and shorten their service life.
- When charging the batteries, first insert them into the battery box, then connect them with the mains; when the batteries are fully charged, first cut off the mains, and then pull them out.
- If you do not need to use the machine for a long period of time, please charge the batteries fully and disconnect the positive pole.

3.10 Cleaning of the filter screen

- Remove the filter cover, take out the filter screen and wash it with clean water.



3.11 Cleaning of the filter element of the vibrator

- Open the board of the machine and remove the fixing nuts of the baffle, and take out the filter element.

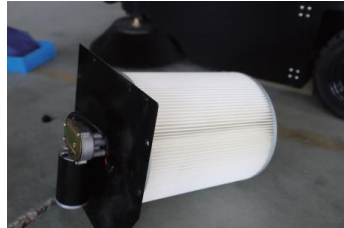

Chapter 4 Common problems and solutions

Problems	Causes	Solutions	
The machine is out of power	The main fuse is blown	Replace the main fuse	
	The batteries have no power output	Charge the batteries (Charge the batteries once a month if the machine is not going to be used for a long time) Replace the broken batteries	
The machine moves abnormally	The driving motor runs well	The chains have fallen out	Reinstall the chains
		The gearbox is broken	Replace the gearbox
	The driving motor runs abnormally	The driving motor is broken	Replace the driving motor
		The driving motor controller is broken	Replace the driving motor controller
	The accelerator panel is broken	Replace the accelerator panel	
The main groom does not work	The fuse is blown	Replace the fuse	
	The belt of the main groom is broken	Replace the belt of the main groom	
	The main groom motor is broken	Replace the main groom motor	
The side grooms do not work.	The fuse is broken	Replace the fuse	
	The side brush motor is broken	Replace the side brush motor	
The brushes do not rise or fall	The fuse of the pushing rod is blown	Replace the fuse	
	The relay is broken	Replace the relay	
	The pushing rod motor is broken	Replace the pushing rod motor	
The cleaning effects are not good	The brushes are worn	Replace the worn brushes	
	The brushes are entangled	Remove the entanglements	
	The baffle are worn	Replace the worn baffles	
	The machines moves too fast	Reduce the speed	
	The ventilator has a fault	The ventilator works	Start the dust-vibrating button
		The ventilator does not work	Replace the ventilator
Leaves or large garbage cannot be cleaned completely	The brushes are too high	Adjust the height of the brushes	
	The brushes are entangled	Remove the entanglements	
	The machines moves too fast	Reduce the speed	
Dust or fine ashes cannot be cleaned completely	The filter element is blocked	Clean or replace the filter element	
	The baffles are broken	Replace the broken baffles	
The garbage moves forward	The front baffle is broken	Replace the front baffle	
The brushes become worn very quickly	The brushes are pressed too tightly	Adjust the height of the brushes	
	The ground is too rough	No solution available	
The garbage can leaks	The sealing strip of the garbage can is broken	Replace the sealing strip of the garbage can	
The batteries cannot be charged	The batteries are broken	Replace the broken batteries	
	The charger is broken	Replace the charger	
	The battery connecting cables are loose	Tighten the loose battery connecting cables	
The batteries discharge too quickly	The batteries are not well charged	Charge the batteries	
	The batteries are broken	Replace the broken batteries	

Chapter 5 Maintenance

Regular maintenance is necessary in order for the machine to be in its best condition, as well as to extend its service life and ensure the operator's safety. The time interval of maintenance can be changed under certain circumstances, but this must be determined by a professional technician.

When performing maintenance, make sure that the machine is turned off and the key is removed from the switch.

5.1 Operating conditions

- Temperature: -10 °C ~ 40 °C
- Relative humidity: 5%~70%
- No electricity-conductive and explosive gases or dust are presented
- No corrosive gases or vapor are presented
- Well ventilated indoor environment

5.2 Maintenance timetable

Items	Upon receiving	Every 10 h	Every 50 h	Every 100 h	Every 200 h	Every 500 h
Height of the brush plates						
Are the brush plates entangled?						
Belt of the main groom						
Dust suction motor and filter element						
Baffles						
Dust-vibrator motor						
Are all nuts and screws tightened?						
Degree of wear of the brake						
Degree of wear of the brushes						
Are all the driving chains tightened?						

Chapter 6 After-sale services

6.1 General description

- Seven-day guaranteed return, fifteen-day guaranteed replacement, one-year warranty for the whole machine, 6-month warranty for damaged parts, and no warranty for consumables (calculated from the next day after receiving the machine).
- The delivery receipt and purchase invoice are certificates for warranty and must be kept properly.

6.2 Contents of warranty

Category	Contents	Warranty period
The entire machine	Sheet metal parts, batteries, motors, controllers, accelerator pedal, relay, charger, spray gun, high-pressure pump, brake assembly	1 year
Damaged parts	Shock attenuator, inner springs, wheels, nozzles, lights, bearings, universal wheels, fuses	6 months
Consumables	Side brush, main groom, filter element, baffle, conveyor belt, sealing strip, high pressure water pipe	No warranty

6.3 Cases not covered in the warranty

- The operator fails to perform maintenance according to the instruction manual, resulting in damage or failure.
- The surface and/or the structure of the machine are obviously damaged due to improper operation.
- Disassembly or modification not approved by the original manufacturer.
- Damage due to weather or force majeure.
- The warranty is expired or the machine has been used for more than 1,500 hours.

Warranty Card

用户名 User's name		联系电话 Tel	
通讯地址 Address		票据号 Bill No.	
购买时间 Date of purchase		机身编号 Serial number	
产品型号 Type of product		日期 Date	
更换配件： Accessories to be replaced:			
故障描述： Fault description:			

Anhui Chancee Technology Co., Ltd.

Direction: 11 Qiaowan Road, Heifei, Anhui, China

Website: www.chanceeglobal.com

